

# **SIGNODE** **LBX-2330**™

***Automatic plastic strapping machine***

- ***Unmatched simplicity — Easy to operate and maintain***
- ***Jam-resistant technology***
- ***Non-directional strap loading***

***Up to***  
***70***  
***straps per***  
***minute!***



**Made in  
the U.S.A.**

**SIGNODE®**

# SIGNODE LBX-2330™ Automatic plastic strapping machine

The new LBX-2330™ automatic strapping machine is the simplest, most reliable general-duty strapping machine on the market today. With 40% fewer parts and more timesaving features, the LBX-2330 machine simplifies operation and maintenance to save you time and money.

## Strap feeds from either direction

Strap coil pays off from either direction, eliminating the downtime and material waste resulting from incorrect coil loading.

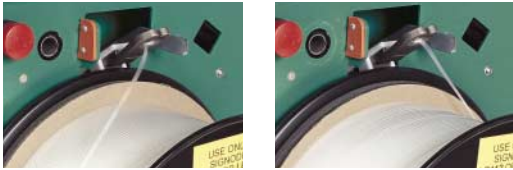

## Out-of-strap feature

The out-of-strap feature ejects the strap at the end of the coil to eliminate downtime associated with removing the excess strap left in the machine.

## Easy maintenance

No drive belts or clutches. Hot knife can be removed and cleaned without the use of any tools.



## Variable speed conveyor

The LBX-2330's standard variable speed conveyor easily integrates with your existing conveyor system, providing for easy set-up and operation.

## Fully accessible strap path

No tools required. Simply raise the tabletop and lift guard for access to strap path.



## Toolless conveyor removal

Conveyors can be easily removed for maintenance.

## Automatic cut-off and refeed option

Signode's patented automatic cut-off and refeed feature automatically ejects misfed strap, rethreads itself and continues strapping without operator intervention.

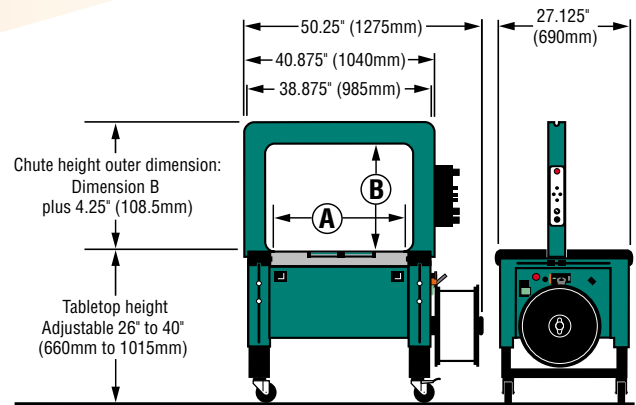

LBX-2330 Chute inner dimensions

	in.	mm	in.	mm	in.	mm	in.	mm	in.	mm
A*	20	510	28	710	33	840	48	1220	48	1220
B	15	380	20	510	30	760	20	510	48	1220

\*Inner dimension A is maximum package size.

## LBX-2330 Specifications

**Cycle rate:** Up to 70 straps per minute. Actual production will vary depending on package size, chute size and operator dexterity.

**Maximum package weight:** 100 lbs on machine or conveyor

**Strapping:** 5mm or 6mm polypropylene strapping

**Strap tension:** Adjustable from 2 lbs to 60 lbs

**Electrical requirements:**

208 volt, 60Hz; 230 volt, 60Hz; 460 volt, 60Hz; 575 volt, 60Hz

**Shipping weight:** 600 lbs

## LBX-2330 Options

- Single or dual compression  
Single: Up to 120 lbs at 90 lbs psi  
Dual: Up to 240 lbs at 90 lbs psi
- Indicator light alerts operator to low strap/out-of-strap conditions and machine malfunction
- EZ adjustable leg kit — 26" to 40" (660mm to 1015mm)
- Automatic cut-off and refeed
- Conveyor interlock kit

*The LBX is also available in two semiautomatic models, the LBX-2000 and the LBX-2300.*

## Save up to 20% on material costs with LB Series plastic strapping

The new LBX-2330 utilizes Signode's newest Contrax® polypropylene strapping. LB Series strapping has the same durable properties as regular Contrax with more strap per coil.

- LB 112 5mm Contrax coils — 30,000 feet per coil
- LB 212 6mm Contrax coils — 24,000 feet per coil

**SIGNODE®**

3610 West Lake Avenue  
Glenview, Illinois 60026  
1-800-323-2464  
www.signode.com